

KRT18BM

Multicolor contrast sensor

en 01-2016/06 50133232

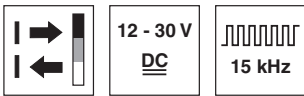

13mm



- RGB transmitter
- Maximum packing quality through short response time
- Automatic luster suppression
- Multiple teach modes in one device

Dimensioned drawing

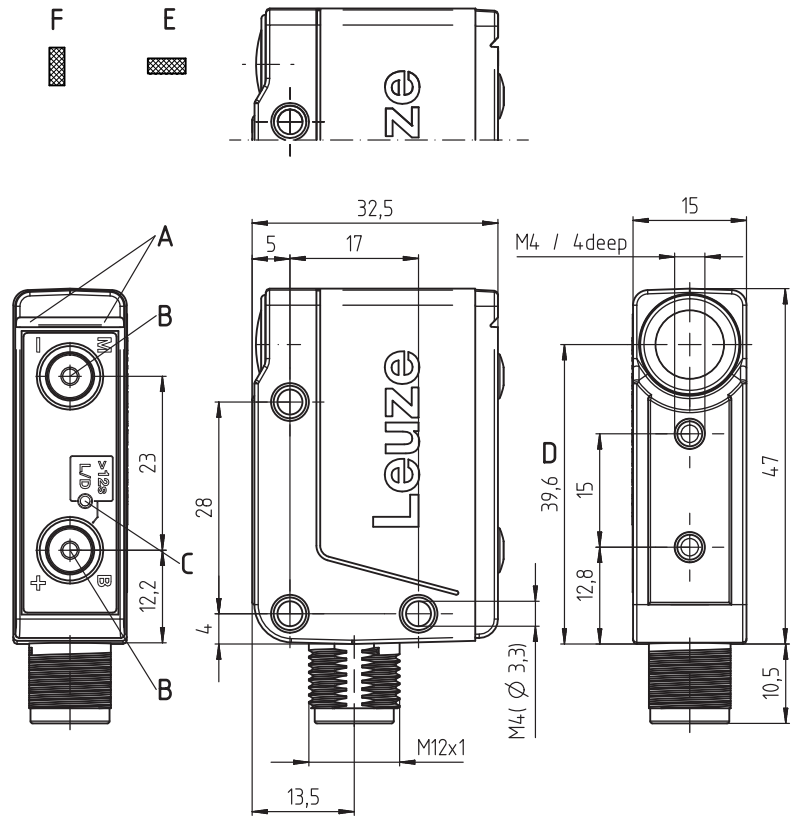

- A** Indicator diodes
- B** Teach buttons
- C** Display of the special functions
- D** Optical axis
- E** Horizontal light spot orientation (transverse)
- F** Light spot orientation vertical (lengthwise)

Electrical connection

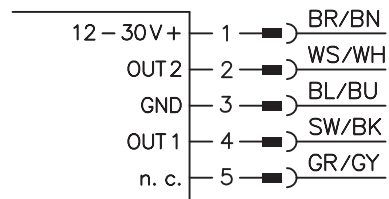

We reserve the right to make changes • DS_KRT18BM_3_en_50133232.fm



Accessories:

- (available separately)
- Mounting systems (BTU 200M..., BT 95)
 - Mounting adapter for standard design (80 mm x 53 mm x 30 mm) BTX 018M
 - Cable with M12 connector (K-D M12...)

Technical data

Optical data

Scanning range	13mm ± 3mm
Light source ¹⁾	LEDs (red, green, blue)
Light spot dimensions	1mm x 4mm (at a distance of 13mm)
Light spot orientation	vertical (lengthwise) or horizontal (transverse)

Timing

Switching frequency	15kHz
Response time	33µs
Conveyor speed (during dyn. 2-point teach)	≤ 0.1 m/s (with 1mm mark width)
Readiness delay	< 300ms

Electrical data

Operating voltage U _B ²⁾	12 ... 30VDC (incl. residual ripple)
Residual ripple	≤ 15% of U _B
Open-circuit current	25mA (at 24V)
Switching outputs/functions	OUT1 push-pull switching output (high signal on mark) OUT2 push-pull switching output (low signal on mark)
Signal voltage high/low	≥ (U _B -2V) ≤ 2V
Output current	max. 100mA

Indicators

Green LED continuous light	ready
Yellow LED continuous light	mark detected
Green and yellow LED flashing (2Hz)	teach-in active
Green and yellow LED flashing (8Hz)	teaching error
Yellow LEDs - special functions	light/dark switching

Mechanical data

Housing	diecast zinc, chemically nickel-plated
Connector	diecast zinc, chemically nickel-plated
Optics	PMMA
Operation	2 teach buttons for mark (M) and background (B)
Weight	60g
Connection type	M12 connector, 5-pin

Environmental data

Ambient temp. (operation/storage)	-40°C ... +60°C/-40°C ... +70°C
Protective circuit ³⁾	2, 3
VDE safety class ⁴⁾	III
Degree of protection	IP67, IP 69K
Light source	exempt group (in acc. with EN 62471)
Standards applied	IEC 60947-5-2
Certifications	UL 508, C22.2 No.14-13 ^{2) 5)}
Chemical resistance	tested in accordance with ECOLAB

Additional functions

2 teach processes	static teach on background and mark dynamic teach on background and mark
Light/dark switching (L/D)	can be activated via control button

- 1) Average life expectancy 100,000h at an ambient temperature of 25°C
- 2) For UL applications: use is permitted exclusively in Class 2 circuits according to NEC
- 3) 2=polarity reversal protection, 3=short circuit protection for all transistor outputs
- 4) Rating voltage 50V
- 5) These proximity switches shall be used with UL Listed Cable assemblies rated 30V, 0.24A min. in the field installation, or equivalent (categories: CYJV/CYJV7 or PVVA/PVVA7)

Notes

Observe intended use!

- ☞ This product is not a safety sensor and is not intended as personnel protection.
- ☞ The product may only be put into operation by competent persons.
- ☞ Only use the product in accordance with its intended use.

● **Glossy objects:**

With glossy objects, the sensor is to be fastened at an inclination of approx. 10° ... 15° relative to the object surface.

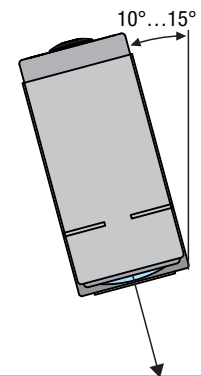

● **Alignment aid:**

An alignment aid is included in the scope of delivery of each sensor. This facilitates simple alignment of the sensor to the working distance of 13 mm without needing to perform electrical commissioning.

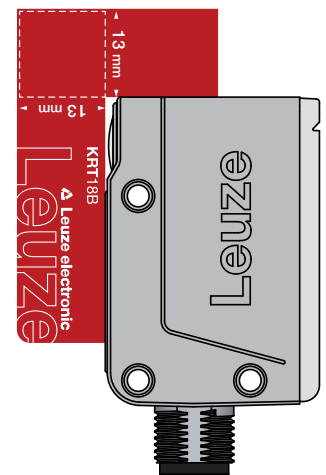

KRT18BM

Multicolor contrast sensor

Part number code

K	R	T	1	8	B	M	.	H	3	/	G	6	X	-	M	1	2
---	---	---	---	---	---	---	---	---	---	---	---	---	---	---	---	---	---

Operating principle

KRT Contrast sensor

Series

18B 18B series

Light source

M Multicolor RGB

Light spot orientation

H Horizontal (transverse)

V Vertical (lengthwise)

Setting

3 Teach-in

Pin assignment of connector pin 4 / black cable wire (OUT1)

G Push-pull switching output, PNP active on mark, NPN active on background

Pin assignment of connector pin 2 / white cable wire (OUT2)

6 Push-pull switching output, PNP active on background, NPN active on mark

Pin assignment of connector pin 5 / gray cable wire

X No contact (n. c. - not connected)

Connection technology

M12 M12 connector, 5-pin

Order guide

The sensors listed here are preferred types; current information at www.leuze.com

Order code	Part no.	Features
KRT18BM.V3/G6X-M12	50131248	Light spot orientation vertical (lengthwise), selectable additional function: light/dark switching
KRT18BM.H3/G6X-M12	50131249	Light spot orientation horizontal (transverse), selectable additional function: light/dark switching

Accessories

BTX 018M	50133412	Mounting adapter for mounting on mounting devices for sensors in the standard design (80 mm x 53 mm x 30 mm)
----------	----------	--

Mounting adapter BTX 018M

With the help of mounting adapter BTX 018M (part no. 50133412), contrast sensors KRT18B... can be mounted on existing mounting devices for contrast sensors in the standard design (80mm x 53mm x 30mm).

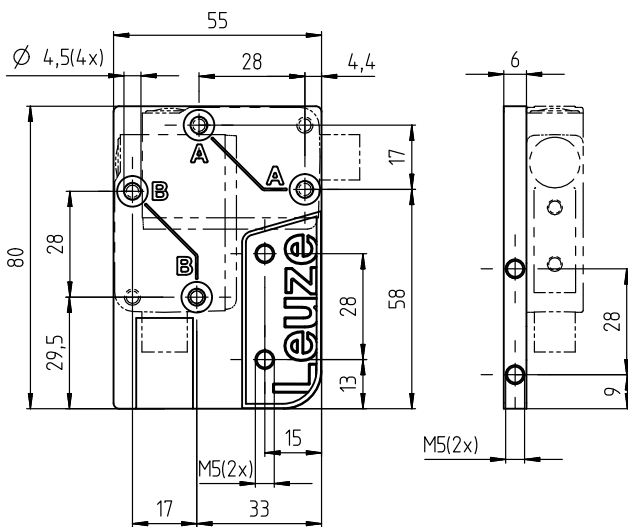

Sensor setting via teach button

Static 2-point teach

Suitable for manual positioning of the marks.

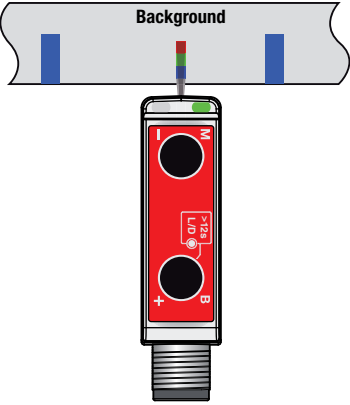
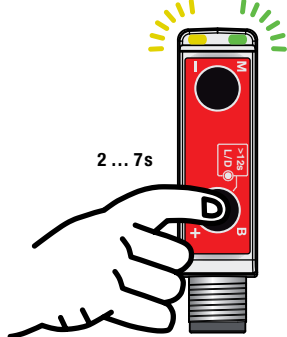
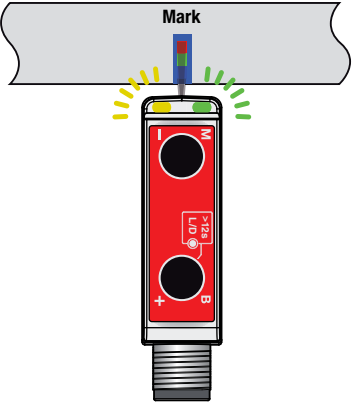
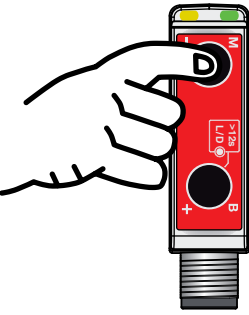
<p>Position the background.</p> 	<p>Press the B button (background) for 2 ... 7s and release.</p>  <p>2 ... 7s</p> <p>Value for background is accepted. LEDs flash synchronous (2Hz).</p>	<p>Position the mark.</p> 	<p>Briefly press the M button (mark) and release.</p>  <p>Value for mark is accepted. Sensor in RUN mode.</p> <p>In the event of a teaching error (insufficient contrast between background and mark), the LEDs flash rapidly (8 Hz). Press button again to reset.</p>
--	---	---	---



The static 2-point teach can be performed in the reverse order in an analogous manner (first teach the mark).

Dynamic 2-point teach

Suitable for applications in which the mark can be positioned under the light spot only with great effort.

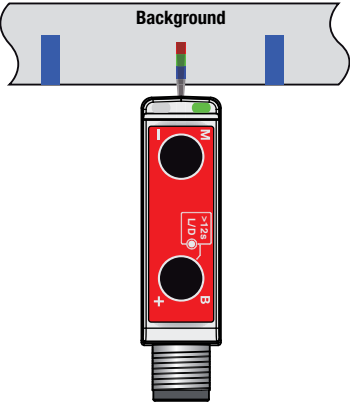
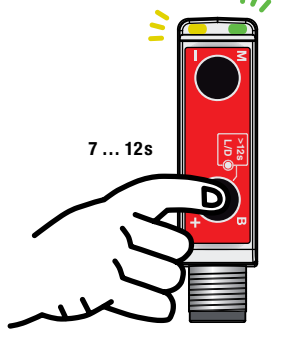
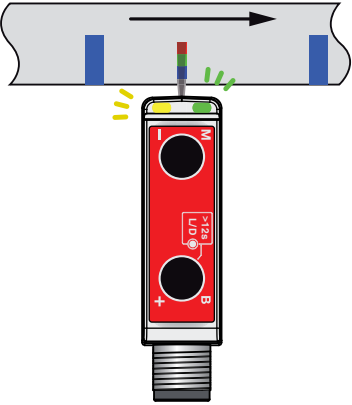
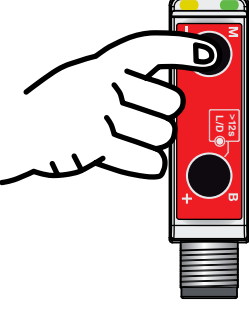
<p>Position the background.</p> 	<p>Press the B button (background) button for 7 ... 12s and release.</p>  <p>7 ... 12s</p> <p>Measurement window opens. LEDs flash alternately (2Hz).</p>	<p>Allow marks to pass through dynamically.</p> 	<p>Briefly press the M button (mark) and release.</p>  <p>Measurement window closes. Sensor in RUN mode.</p> <p>In the event of a teaching error (insufficient contrast between background and mark), the LEDs flash rapidly (8 Hz). Press button again to reset.</p>
--	--	---	--

Fine tuning the switching threshold

The KRT18B... contrast sensor enables fine adjustment of the switching threshold to optimally adapt the sensor to the application.



The fine adjustment should be performed only after a teach-in.

Briefly pressing the '-' button reduces the sensitivity of the sensor. In the case of dark marks on a light background, the button must then be pressed once or twice if the mark is not reliably detected.

Briefly pressing the '+' button increases the sensitivity of the sensor. In the case of dark marks on a light background, the button must then be pressed once or twice if the sensor switches erroneously at locations on the background.

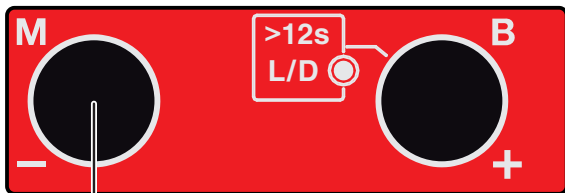

Button '-'

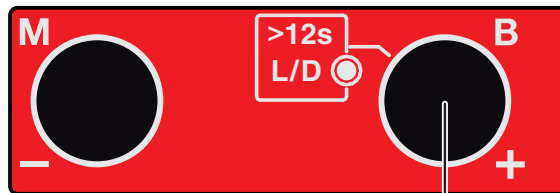

Button '+'

L/D – Light/dark switching

Press the **B** button longer than 12s.

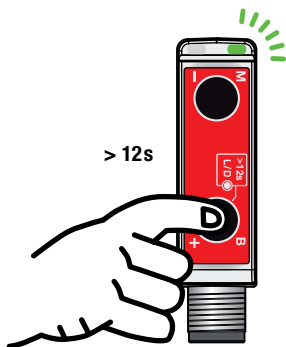

Only the green LED flashes.

Release the button.



LED on =
OUT1 (Pin 4): low signal on mark
OUT2 (Pin 2): high signal on mark



LED off =
OUT1 (Pin 4): high signal on mark
OUT2 (Pin 2): low signal on mark

To change the setting again, press the **B** button again for longer than 12s and release.

